

PROJECT	
TYPE	
SPECIFIER	
QUANTITY	
DATE	

BIONIQ SQUARE ADJUSTABLE RECESSED

A35356-

base number	Color	Finishes	Finishes	Reflector
	Temperature	(Diamond)	(Triangle)	Options

- To build a product code in our configurator select the specify button on the base model # product page
- To build a manual product code on this datasheet choose from the options listed below in blue font and add the suffix to the base model #

GENERAL

Series: Bioniq
 Subseries: Bioniq Square Adjustable
 Brand: Prolicht
 Division: Architectural
 Mounting Type: Recessed
 Mounting Location: Ceiling
 Subcategory: Downlight

PHYSICAL

Shape: Square
 Length (mm): 119
 Length (in): 4 ¹¹/₁₆"
 Width (mm): 119
 Width (in): 4 ¹¹/₁₆"
 Depth (mm): 132
 Depth (in): 5 ³/₁₆"
 Ceiling Thickness (mm): 10 / 12.5 / 15
 Ceiling Thickness (in): 3/8 or 1/2 or 9/16
 Min. Recessing Depth (mm): 150
 Min. Recessing Depth (in): 5 ⁷/₈"
 Light Distribution: Adjustable / Downlight
 Weight (kg): 0.542
 Weight (lbs): 1.2
 Fixture Finish: SSR / BKV / CWI / CRY / HAB / UFT / ITA / RUA / FTG / MYG / LOD / PUS / FRO / FUP / KIA / POP / BLS / SPG / MEY / GOH / GUM / CHC / COM / ABZ / JAG / OBR / MOS / ROR
 Fixture Material: Aluminum Die Cast
 Cut-out Measurements: 114mm / 4 1/2" x 114mm / 4 1/2"

ELECTRICAL

Lamp Type: LED
 Input Wattage (W): 16.5
 Total Output Wattage (W): 14
 Dimming: Tri-Mode (Non-Dimming and Phase Dimming (120Vac only) and 0-10V Dimming)
 Driver Included: No
 Driver Location: Recessed Housing
 Driver Type: Constant Current - Universal
 Driver Class: Class 2
 Housing: See components
 Input Voltage (V): 120 - 277
 Constant Current (MA): 500

LED

Number of LEDs: 1
 Color Temperature (°K): 2700 / 3000 / 3500 / 4000
 Max. Delivered Lumen (lm): 940 / 980 / 1029 / 1050
 Nominal Lumen (lm): 1386 / 1438 / 1511 / 1542
 CRI: >90 CRI
 Lamp Life (hrs): 50000

OPTICAL

Reflector°: 20 / 40 / 60
 Adjustability: Rotational 355°; Tilt 30°

RATINGS AND CERTIFICATIONS

Certified By: Certified for North American Standards
 IP rating: IP20



BIONIQ SQUARE ADJUSTABLE RECESSED

A35356-

PROJECT	_____
TYPE	_____
SPECIFIER	_____
QUANTITY	_____
DATE	_____



A

BIONIQ SQUARE ADJUSTABLE COMFORT RECESSED

A35362- _____
 base number Color _____ Finishes _____ Finishes _____ Finishes _____ Reflector
 Temperature (Diamond) (Triangle) (Circle) Options

- To build a product code in our configurator select the specify button on the base model # product page
- To build a manual product code on this datasheet choose from the options listed below in blue font and add the suffix to the base model #

GENERAL

Series: Bioniq
 Subseries: Bioniq Square Adjustable Comfort
 Brand: Prolight
 Division: Architectural
 Mounting Type: Recessed
 Mounting Location: Ceiling
 Subcategory: Downlight

PHYSICAL

Shape: Square
 Length (mm): 119
 Length (in): 4 11/16
 Width (mm): 119
 Width (in): 4 11/16
 Depth (mm): 132
 Depth (in): 5 3/16
 Ceiling Thickness (mm): 10 / 12.5 / 15
 Ceiling Thickness (in): 3/8 or 1/2 or 9/16
 Min. Recessing Depth (mm): 150
 Min. Recessing Depth (in): 5 7/8
 Light Distribution: Adjustable / Downlight
 Weight (kg): 0.607
 Weight (lbs): 1.34
 Fixture Finish: SSR / BKV / CWI / CRY / HAB / UFT / ITA / RUA / FTG / MYG / LOD / PUS / FRO / FUP / KIA / POP / BLS / SPG / MEY / GOH / GUM / CHC / COM / ABZ / JAG / OBR / MOS / ROR
 Fixture Material: Aluminum Die Cast
 Cut-out Measurements: 114mm / 4 1/2" x 114mm / 4 1/2"

ELECTRICAL

Lamp Type: LED (Zhaga Standard)
 Input Wattage (W): 16.5
 Total Output Wattage (W): 14
 Dimming: Tri-Mode (Non-Dimming and Phase Dimming (120Vac only) and 0-10V Dimming)
 Driver Included: No
 Driver Location: Recessed Housing
 Driver Type: Constant Current - Universal
 Driver Class: Class 2
 Input Voltage (V): 120 - 277
 Constant Current (MA): 500

LED

Number of LEDs: 1
 Color Temperature (°K): 2700 / 3000 / 3500 / 4000
 Max. Delivered Lumen (lm): 940 / 980 / 1029 / 1050
 Nominal Lumen (lm): 1386 / 1438 / 1511 / 1542
 CRI: >90 CRI

OPTICAL

Reflector: 20 / 40 / 60
 Adjustability: Rotational 355°; Tilt 30°

RATINGS AND CERTIFICATIONS

Certified By: Certified for North American Standards
 IP rating: IP20



BIONIQ SQUARE ADJUSTABLE COMFORT RECESSED

A35362-

For Color / Finish Chart & Symbology see Appendix or product page downloadable area.



	27K	35K	30K	40K	°K
Color Temperature	2700K	3500K	3000K	4000K	
Reflector	20	40	60		
	20°	40°	60°		

ORDER-EXAMPLE: **L3XXXX-** **°K**
02 02 02 30K 20
 Black Black Black 3000K 20°



BIONIQ SQUARE DEEP RECESSED

A35368-

base number Color Finishes Finishes Reflector
 Temperature (Diamond) (Triangle) Options

- To build a product code in our configurator select the specify button on the base model # product page
- To build a manual product code on this datasheet choose from the options listed below in blue font and add the suffix to the base model #

GENERAL

Series: Bioniq
 Subseries: Bioniq Square Deep
 Brand: Prolicht
 Division: Architectural
 Mounting Type: Recessed
 Mounting Location: Ceiling
 Subcategory: Downlight

PHYSICAL

Shape: Square
 Length (mm): 119
 Length (in): 4 11/16
 Width (mm): 119
 Width (in): 4 11/16
 Depth (mm): 150
 Depth (in): 5 7/8
 Ceiling Thickness (mm): 10 / 12.5 / 15
 Ceiling Thickness (in): 3/8 or 1/2 or 9/16
 Min. Recessing Depth (mm): 170
 Min. Recessing Depth (in): 6 11/16
 Light Distribution: Downlight
 Weight (kg): 0.626
 Weight (lbs): 1.38
 Fixture Finish: SSR / BKV / CWI / CRY / HAB / UFT / ITA / RUA / FTG / MYG / LOD / PUS / FRO / FUP / KIA / POP / BLS / SPG / MEY / GOH / GUM / CHC / COM / ABZ / JAG / OBR / MOS / ROR
 Fixture Material: Aluminum Die Cast
 Cut-out Measurements: 114mm / 4 1/2" x 114mm / 4 1/2"

ELECTRICAL

Lamp Type: LED (Zhaga Standard)
 Input Wattage (W): 16.5
 Total Output Wattage (W): 14
 Dimming: Tri-Mode (Non-Dimming and Phase Dimming (120Vac only) and 0-10V Dimming)
 Driver Included: No
 Driver Location: Recessed Housing
 Driver Type: Constant Current - Universal
 Driver Class: Class 2
 Input Voltage (V): 120 - 277
 Constant Current (MA): 500

LED

Number of LEDs: 1
 Color Temperature (°K): 2700 / 3000 / 3500 / 4000
 Max. Delivered Lumen (lm): 940 / 980 / 1029 / 1050
 Nominal Lumen (lm): 1386 / 1438 / 1511 / 1542
 CRI: >90 CRI

OPTICAL

Reflector: 20 / 40 / 60

RATINGS AND CERTIFICATIONS

Certified By: Certified for North American Standards
 IP rating: IP20



BIONIQ SQUARE DEEP RECESSED

A35368-

For Color / Finish Chart & Symbology see Appendix or product page downloadable area.

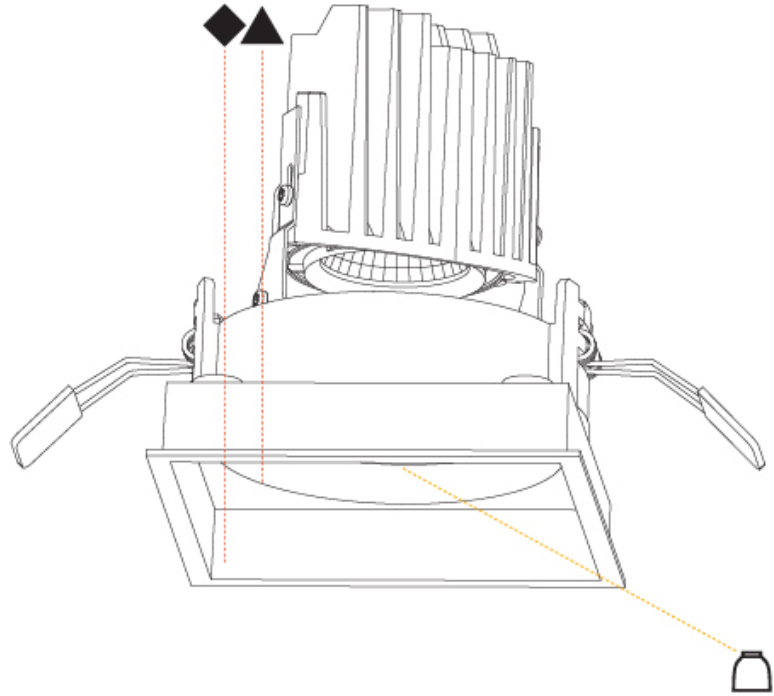

	27K	35K	30K	40K	°K
Color Temperature	2700K	3500K	3000K	4000K	
Reflector	20	40	60		
	20°	40°	60°		

ORDER-EXAMPLE: **◆ ▲ °K**
L3XXXX- 02 02 30K 20
 Black Black 3000K 20°



PROJECT	
TYPE	
SPECIFIER	
QUANTITY	
DATE	

BIONIQ SQUARE DEEP COMFORT RECESSED

A35371-

base number	Color Temperature	Finishes (Diamond)	Finishes (Triangle)	Finishes (Circle)	Reflector Options
-------------	-------------------	--------------------	---------------------	-------------------	-------------------

- To build a product code in our configurator select the specify button on the base model # product page
- To build a manual product code on this datasheet choose from the options listed below in blue font and add the suffix to the base model #

GENERAL

Series: Bioniq
Subseries: Bioniq Square Deep Comfort
Brand: Prolight
Division: Architectural
Mounting Type: Recessed
Mounting Location: Ceiling
Subcategory: Downlight

PHYSICAL

Shape: Square
Length (mm): 119
Length (in): 4 11/16
Width (mm): 119
Width (in): 4 11/16
Depth (mm): 150
Depth (in): 5 7/8
Ceiling Thickness (mm): 10 / 12.5 / 15
Ceiling Thickness (in): 3/8 or 1/2 or 9/16
Min. Recessing Depth (mm): 170
Min. Recessing Depth (in): 6 11/16
Light Distribution: Downlight
Weight (kg): 0.69
Weight (lbs): 1.5
Fixture Finish: SSR / BKV / CWI / CRY / HAB / UFT / ITA / RUA / FTG / MYG / LOD / PUS / FRO / FUP / KIA / POP / BLS / SPG / MEY / GOH / GUM / CHC / COM / ABZ / JAG / OBR / MOS / ROR
Fixture Material: Aluminum Die Cast
Cut-out Measurements: 114mm / 4 1/2" x 114mm / 4 1/2"

ELECTRICAL

Lamp Type: LED (Zhaga Standard)
Input Wattage (W): 16.5
Total Output Wattage (W): 14
Dimming: Tri-Mode (Non-Dimming and Phase Dimming (120Vac only) and 0-10V Dimming)
Driver Included: No
Driver Location: Recessed Housing
Driver Type: Constant Current - Universal
Driver Class: Class 2
Input Voltage (V): 120 - 277
Constant Current (MA): 350

LED

Number of LEDs: 1
Color Temperature (°K): 2700 / 3000 / 3500 / 4000
Max. Delivered Lumen (lm): 940 / 980 / 1029 / 1050
Nominal Lumen (lm): 1386 / 1438 / 1511 / 1542
CRI: >90 CRI
Lamp Life (hrs): 50000

OPTICAL

Reflector: 20 / 40 / 60

RATINGS AND CERTIFICATIONS

Certified By: Certified for North American Standards
IP rating: IP20



BIONIQ SQUARE DEEP COMFORT RECESSED

A35371-

For Color / Finish Chart & Symbology see Appendix or product page downloadable area.

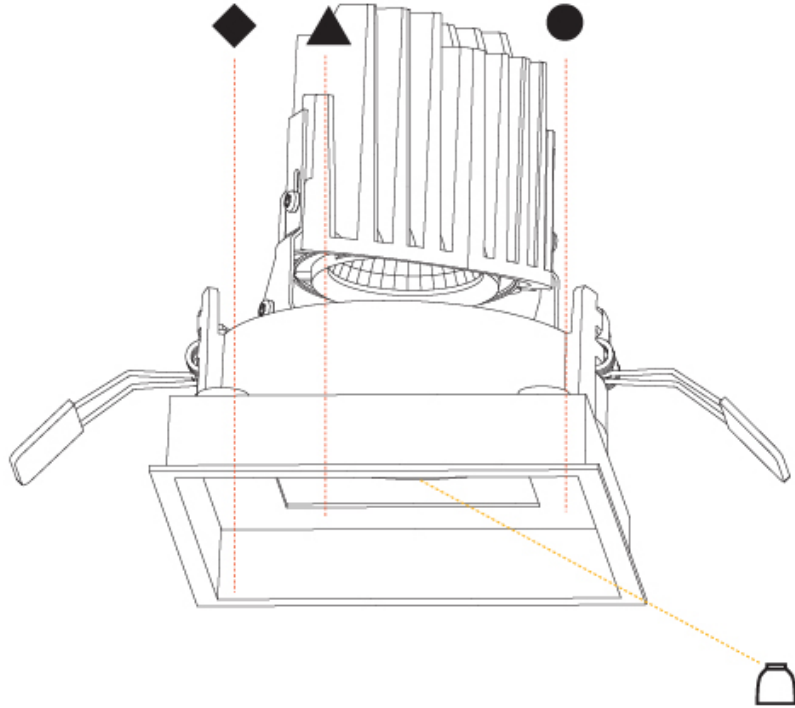

	27K	35K	30K	40K	°K
Color Temperature	2700K	3500K	3000K	4000K	
Reflector	20	40	60		
	20°	40°	60°		

ORDER-EXAMPLE: **◆▲●°K**
L3XXXX- 02 02 02 30K 20
 Black Black Black 3000K 20°



PROJECT
TYPE
SPECIFIER
QUANTITY
DATE

Fixture Finish



Digital: Not all screens are calibrated the same, and therefore, colors will appear differently between screens.

Physical: When texture is involved, there will be variations in color, character and tone within a product series and between product families.

Gun Metal: No Gun Metal finish is alike. It combines a mixture of transparent and black color particles which ensures a highly individual effect and no luminaire being identical.

Champagne Cream, Copper Mine, Ancient Bronze + Jazz Gold: These finishes have slight fading from specific powder coating production. Each luminaire will slightly vary.













PROJECT	
TYPE	
SPECIFIER	
QUANTITY	
DATE	











LEGEND

 floor-mounted	 pivotable	 special LED (upon request) RGB, RGBW, tunable, gold+, meat+, art+, fashion+
 wall and ceiling: recessed and surface mounted	 rotating	 warm dim / natural dimming LED
 ceiling-mounted and wall-mounted	 illuminate tilted	 rechargeable battery powered
 wall-mounted	 color of suspension cable	 fixture with natural vivid LED (upon request)
 omni-directional light distribution	 length of suspension cable	 color rendering index
 direct light distribution	 reflector degree selection	 color temperature
 direct/indirect light distribution	 super spot	 lumen (luminous flux)
 indirect light distribution	 lens	 efficacy (lumens per watt)
 asymmetric light distribution	 lens pack	 Unified Glare Rating (UGR) range from 5-40
 aura light distribution	 shine ring	 marine grade (AISI 316 stainless steel)
 round wall or ceiling cut-out	 integrated shine ring with diffuser	 walk on
 square wall or ceiling cut-out	 free individual colors 01-29	 drive on
 the supplied jig specifies the cutout dimensions	 individual colors: 00 (free of charge), 01-25 (extra charge)	 Dark Sky Compliance
 minimum distance (meters) lamp - object	 luminaire part to be colored (F1)	 Americans with Disabilities Act (less than 4" off the wall located between 27"-84" from floor)
 recessed depth	 luminaire part to be colored (F2)	 lamp protected against explosion
 ceiling thickness in mm	 luminaire part to be colored (F3)	 blown glass using traditional methods by master glass blower
 ceiling thickness selection	 luminaire part to be colored (F4)	 acoustic material
 dimmable DP (phase), DV (0-10V), DD (dali), DS (step-dim)	 luminaire part to be colored (F5)	 protection class I, protection insulation
 included or excluded LED driver/transformer/control gear	 color of 3-circuit adaptor	 protection class II, protection insulation
 separately switchable	 indirect diffuser	 ETL Certified to UL and CSA Standards
 sensor	 direct diffuser	 UL Certified to UL and CSA Standards
 remote control	 ball-proof (upon request)	 CSA Certified to UL and CSA Standards
 available upon request	 accessory	 Certified for North American Standards

IP RATING

 IP20	protected against ingress of solid bodies greater than 12.5mm (finger)
 IP33	protected against ingress of solid bodies greater than 2.5mm protected against sprays of water up to 60 degrees from the vertical (rain)
 IP40	protected against ingress of solid bodies greater than 1mm (wire) no protection against the ingress of moisture
 IP43	protected against ingress of solid bodies greater than 1mm (wire) protected against sprays of water up to 60 degrees from the vertical (rain)
 IP44	protected against ingress of solid bodies greater than 1mm (wire) protected against water splashed from all directions
 IP54	protected against limited ingress of dust (wet rooms/covered outdoor areas) protected against water splashed from all directions
 IP65	protected against ingress of dust protected against jets of water
 IP66	protected against ingress of dust protected against powerful jets of water or heavy seas
 IP67	protected against ingress of dust protected against immersion of water between 15cm - 1m for 30 minutes
 IP68	protected against ingress of dust protected against immersion of water under pressure for long periods

IK RATING

 IK01	protected against 0.14 joules impact (equivalent to 0.25kg mass dropped from 56mm above the surface)
 IK02	protected against 0.2 joules impact (equivalent to 0.25kg mass dropped from 80mm above the surface)
 IK03	protected against 0.35 joules impact (equivalent to 0.25kg mass dropped from 140mm above the surface)
 IK04	protected against 0.5 joules impact (equivalent to 0.25kg mass dropped from 200mm above the surface)
 IK05	protected against 0.7 joules impact (equivalent to 0.25kg mass dropped from 280mm above the surface)
 IK06	protected against 1 joules impact (equivalent to 0.25kg mass dropped from 400mm above the surface)
 IK07	protected against 2 joules impact (equivalent to 0.5kg mass dropped from 400mm above the surface)
 IK08	protected against 5 joules impact (equivalent to 1.7kg mass dropped from 300mm above the surface)
 IK09	protected against 10 joules impact (equivalent to 5.0kg mass dropped from 200mm above the surface)
 IK10	protected against 20 joules impact (equivalent to 5.0kg mass dropped from 400mm above the surface)